

BIBLE

Paper Toys



House 2
With Sheep Pen

General Assembly Instructions

TOOLS NEEDED



- Sharp scissors.
- Paper-cutting knife (recommended: X-Acto knife with a #11 blade).
- Sturdy tweezers with smooth edges. (Tweezers with rough edges or teeth will mar the surface of the pieces.)
- Metal ruler to make a straight cut or score.
- Toothpicks for reaching into tiny corners and spreading drops of glue.
- White glue and glue stick.
- Cutting surface (recommended: a cutting mat).
- Dry pen (no ink) or blunt knife for scoring.

- Print pages 4 to 11 on white card stock paper (sometimes called Cover Paper or Bristol), 160 grammes (recommended) or 190-200 grammes (110 lbs), preferably non glossy but with a mat finish.

Cutting

Usually, a piece for a card stock model is cut out in two stages.

First, the piece is separated from the rest of the pieces by cutting roughly around it with scissors. Don't cut along the lines at this step.

Once the piece is separated, you can work on it without damaging other pieces. It's best to do the scoring and folding before proceeding to the fine cutting.

Work on one piece at a time:

- Score along the dotted lines.
- Cut along the solid lines.
- Fold along the dotted lines, but don't add glue to any pieces yet.

VERY IMPORTANT: Try out the pieces to be glued before applying the glue. This will help you understand how the pieces fit together, and you will be able to take note of any adjustments that might be needed. Then apply a small amount of glue on the tab indicated by a black dot.

Scoring

There are two kinds of folds:

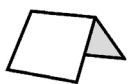

Mountain fold

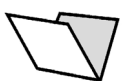
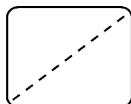

Valley fold

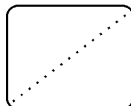

Mountain fold generally means that the texture is on the outside, while on a **valley fold** the texture is usually inside.

Score the fold lines to make a crisp straight fold. It's especially important for the smallest pieces to be scored before folding. To score, place a metal ruler along the fold line, and then press with a dull point (a dry pen or dull knife) along the fold line to compress the paper. This will help to achieve a crisp fold.

Most pieces on the model require a **mountain fold**, though a few use a **valley fold**. Valley folds will be indicated on the model pieces with the valley fold symbol.

www.mylittlehouse.org

Copyright © 2016 by Didier Martin. All rights reserved. No parts of this product may be reproduced in any form, by any electronic or mechanical means without permission in writing from the author.

House 2

Refer to
“Houses How To”
 for instructions and tips
 on how to assemble the
 houses

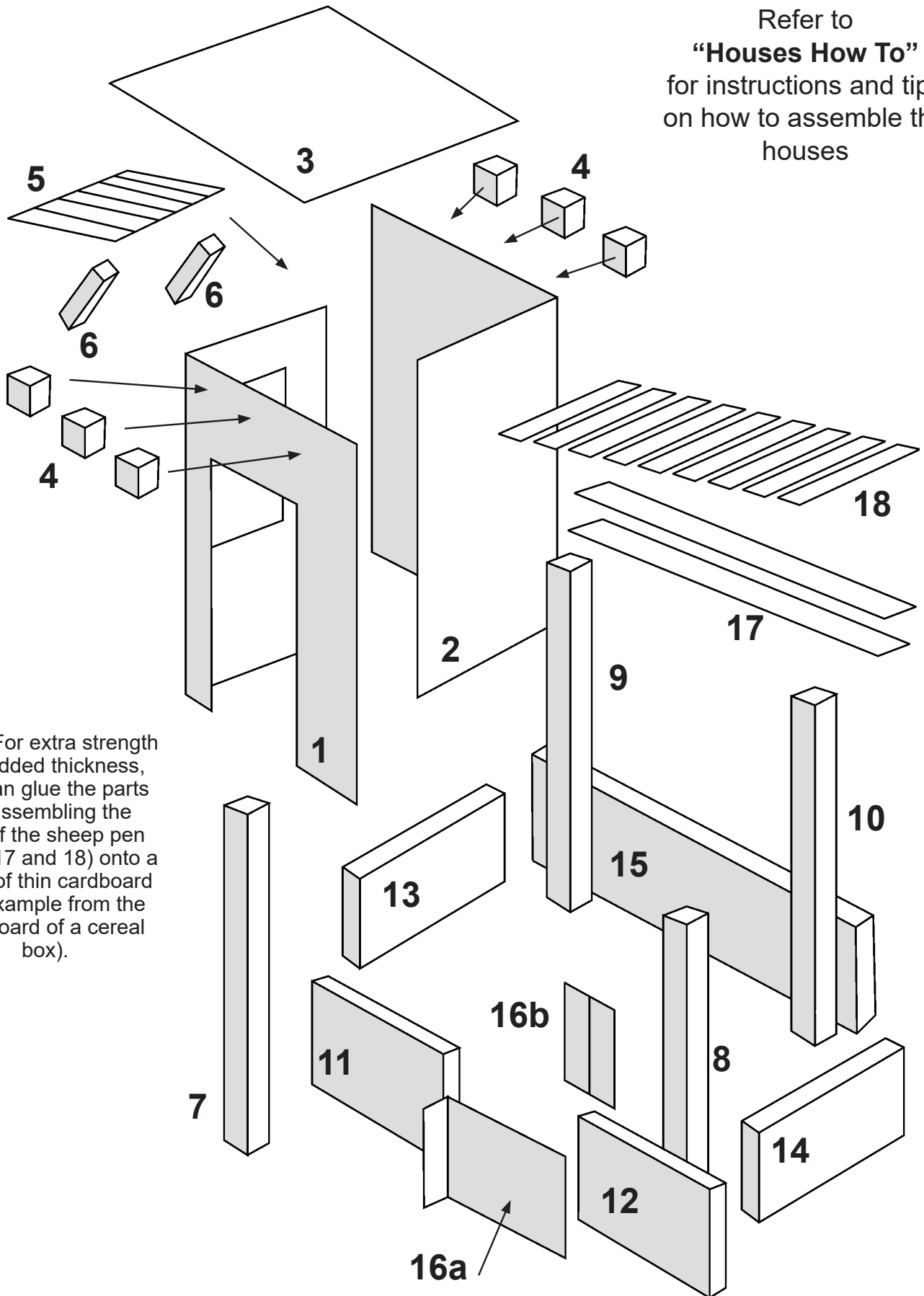

TIPS: For extra strength and added thickness, you can glue the parts for assembling the roof of the sheep pen (parts 17 and 18) onto a piece of thin cardboard (for example from the cardboard of a cereal box).

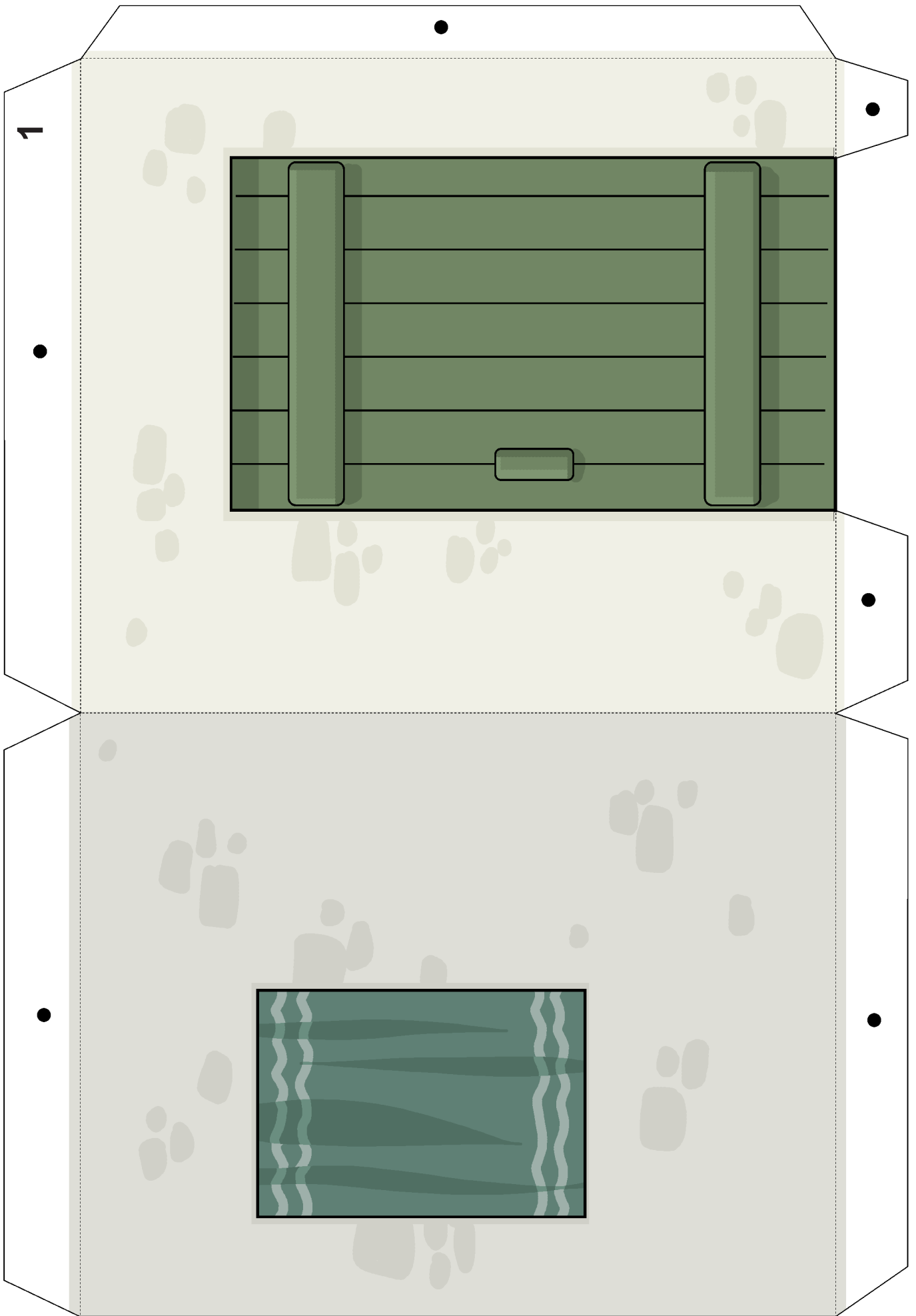

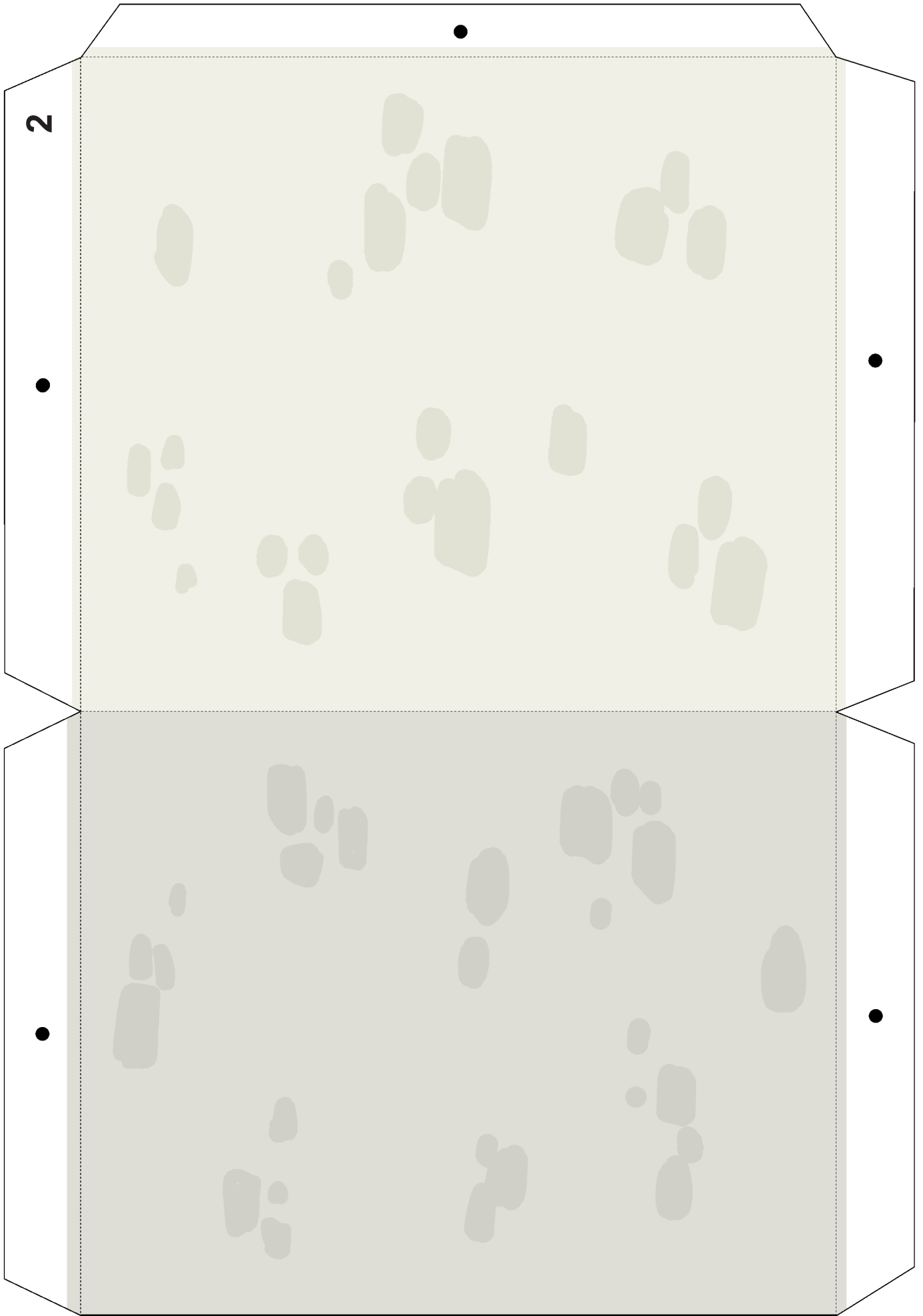

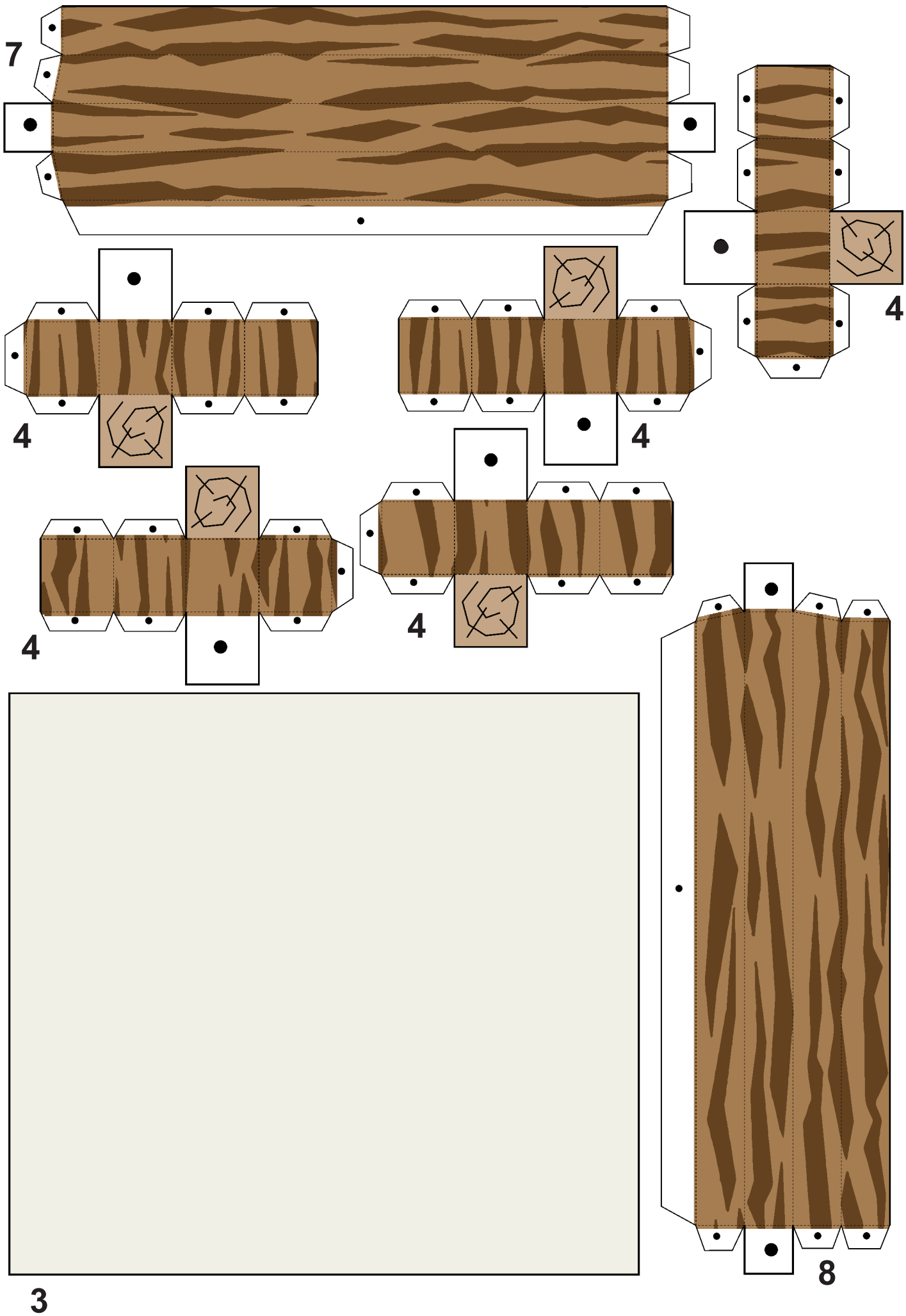

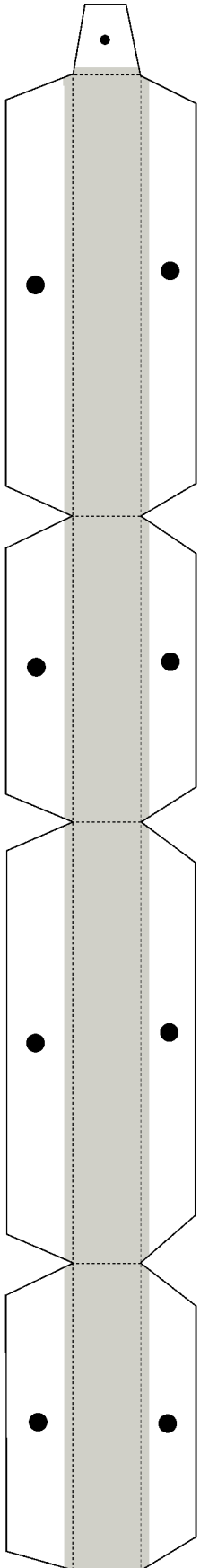
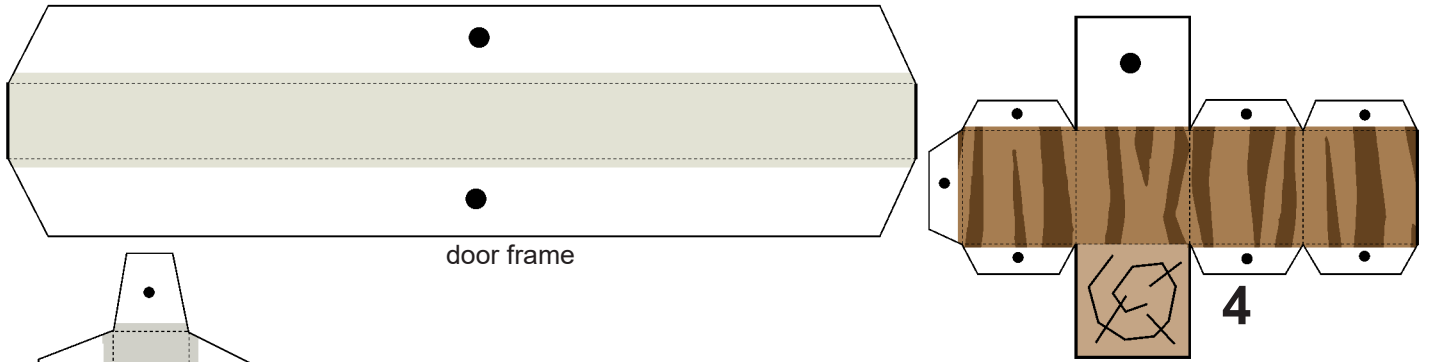

window frame

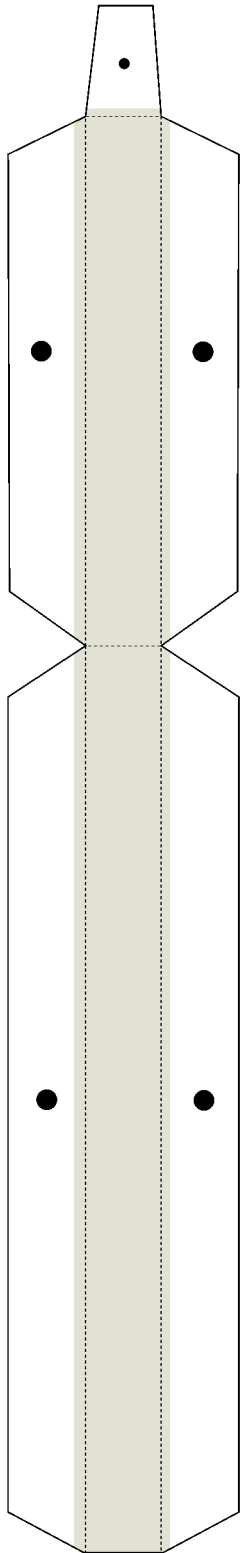

door frame

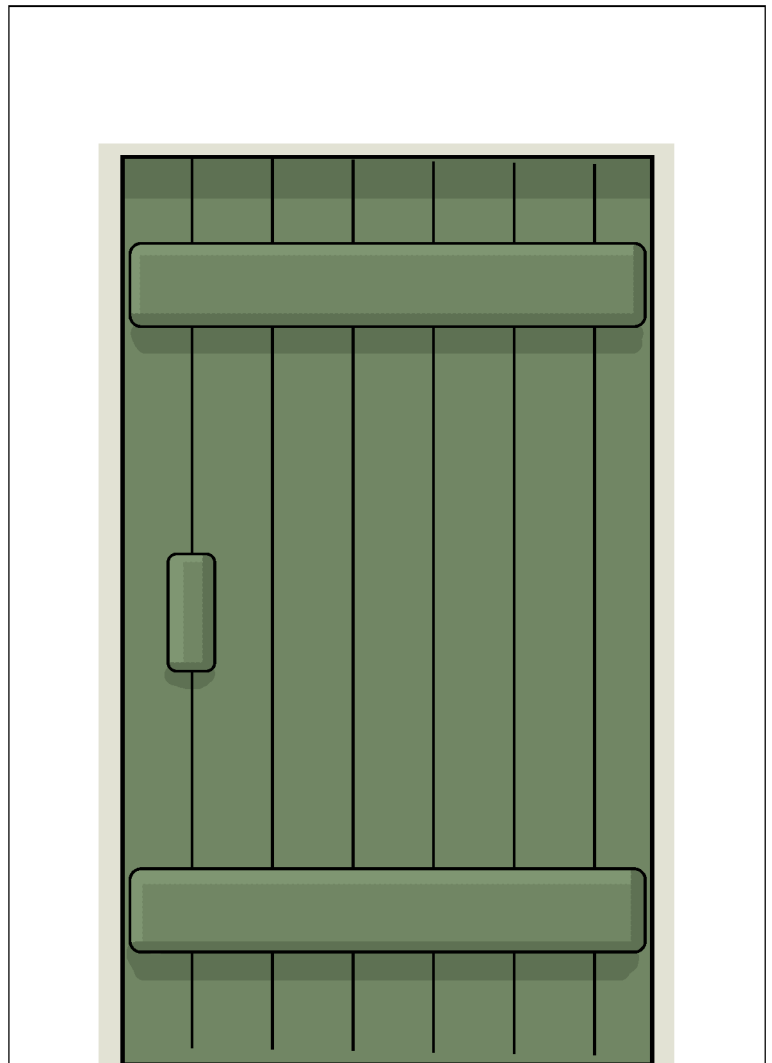
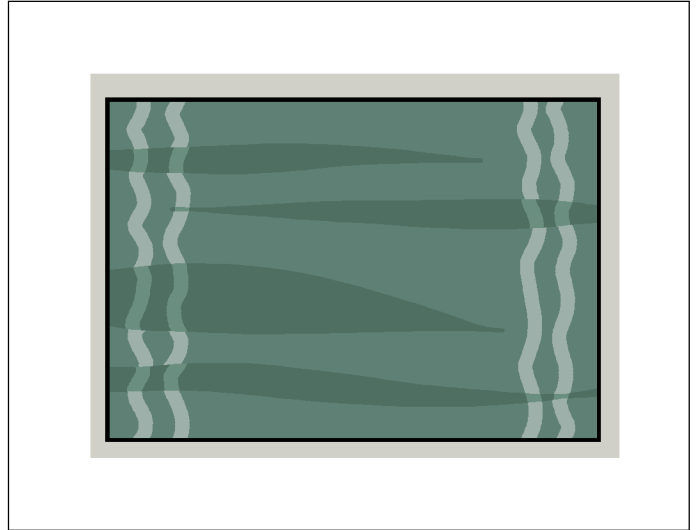

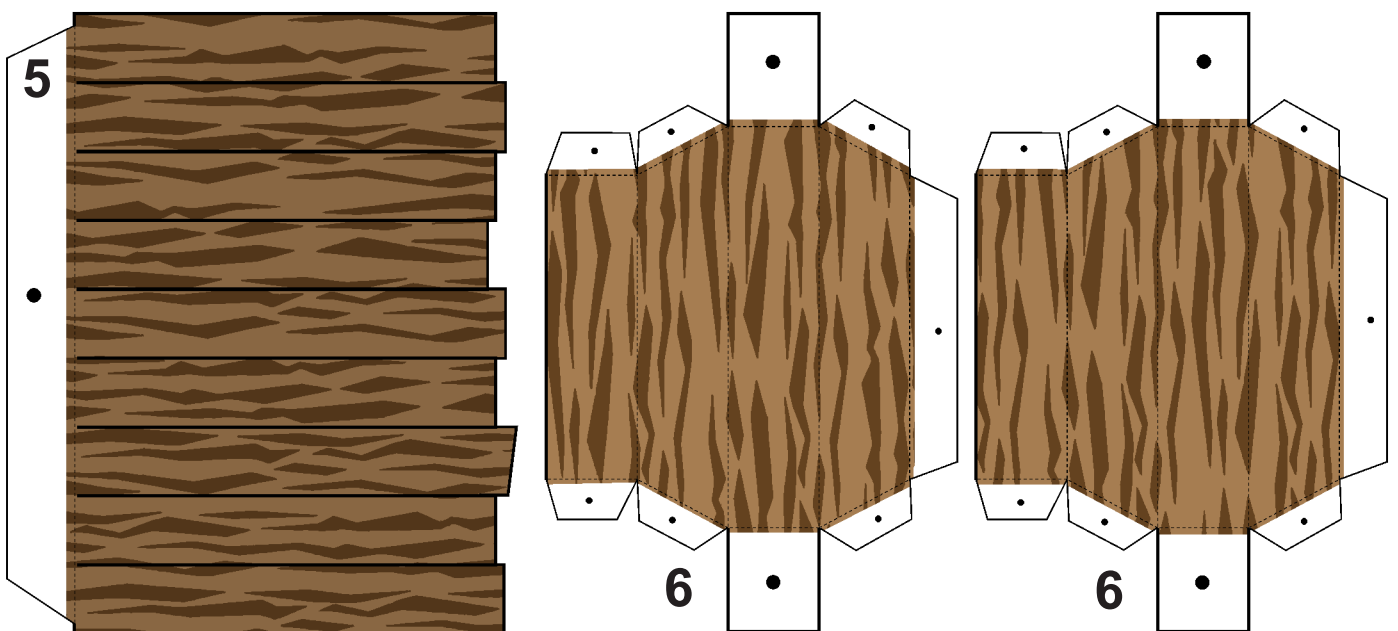
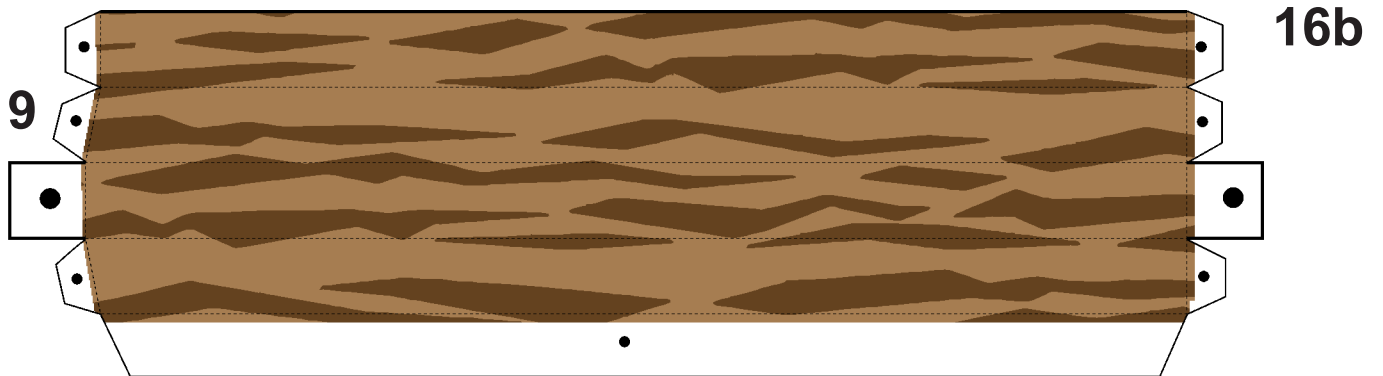
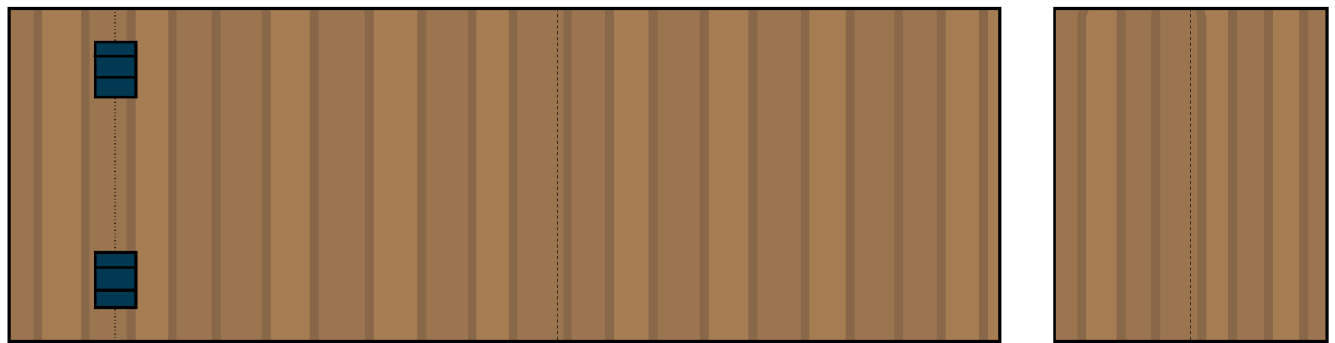
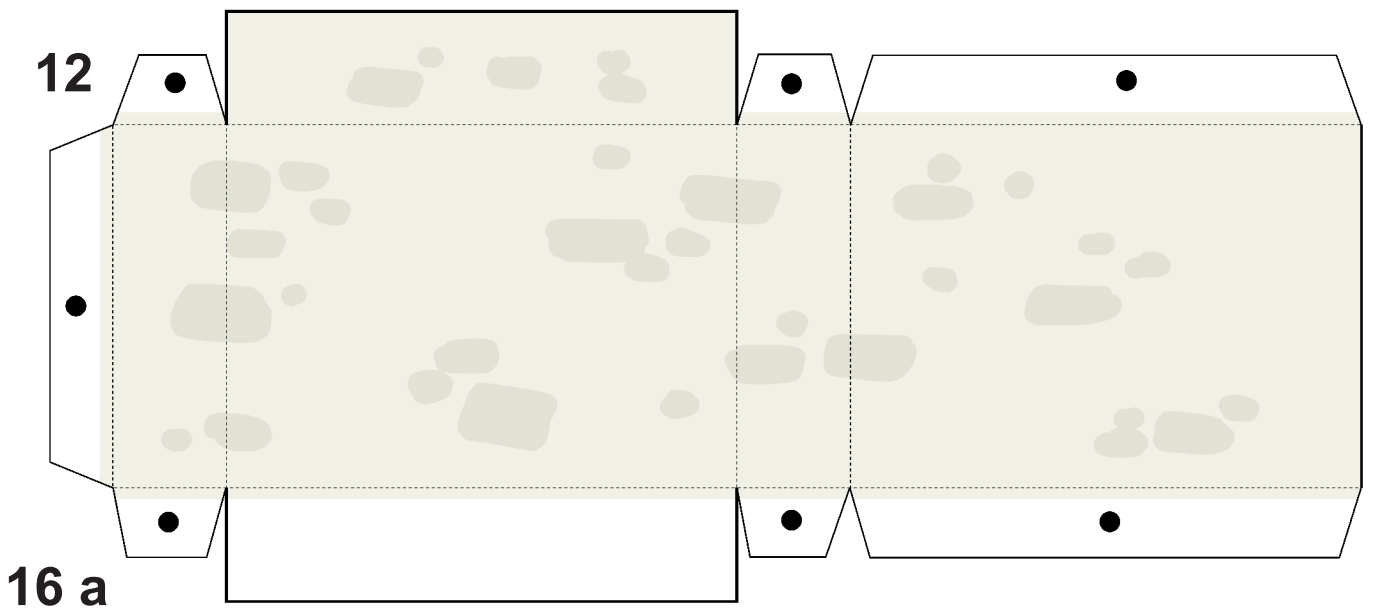



17



17

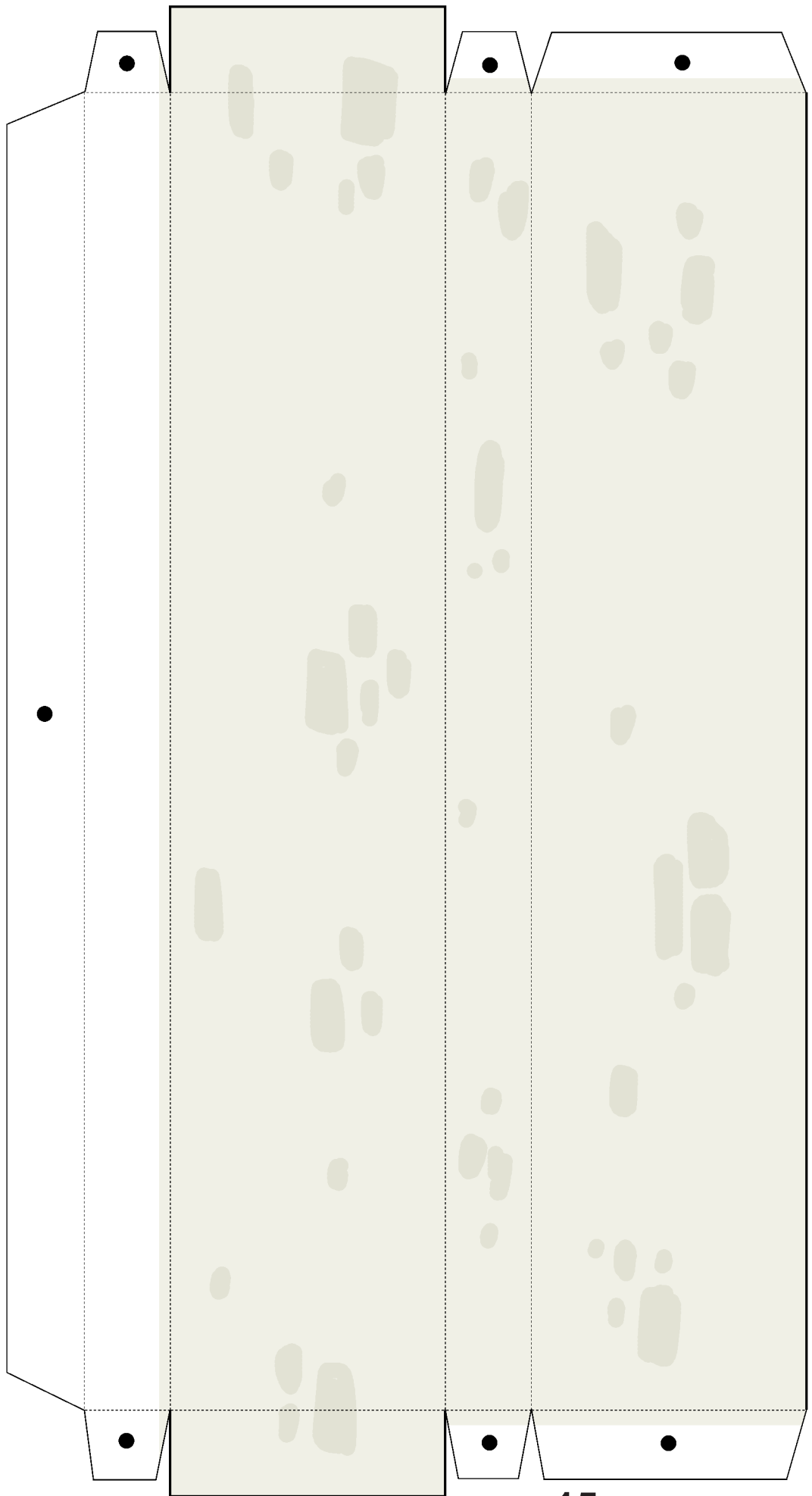

15

13

14

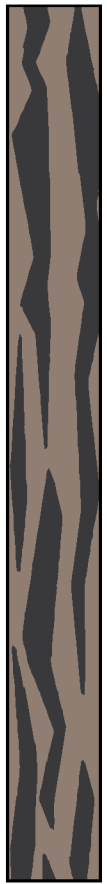
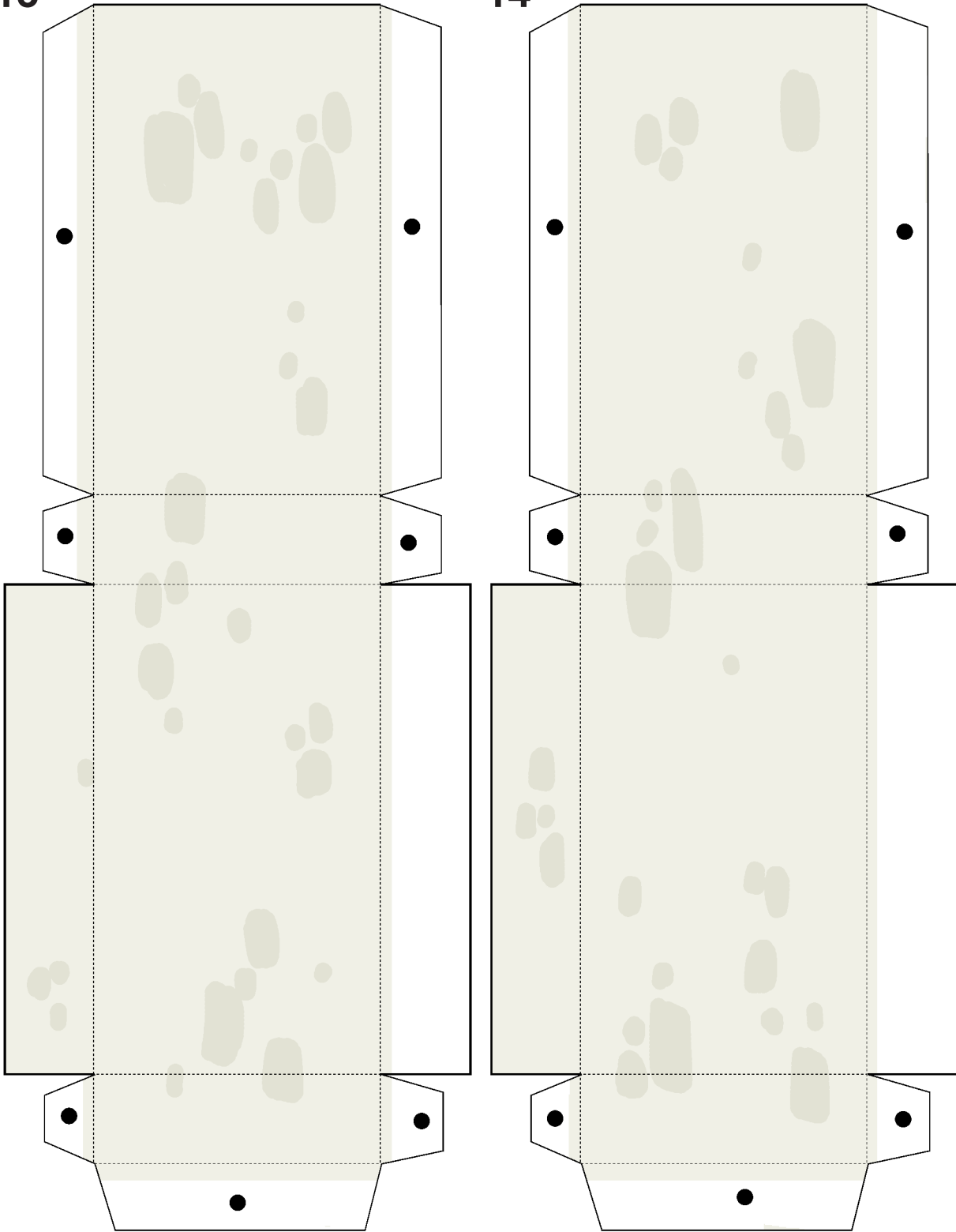

18

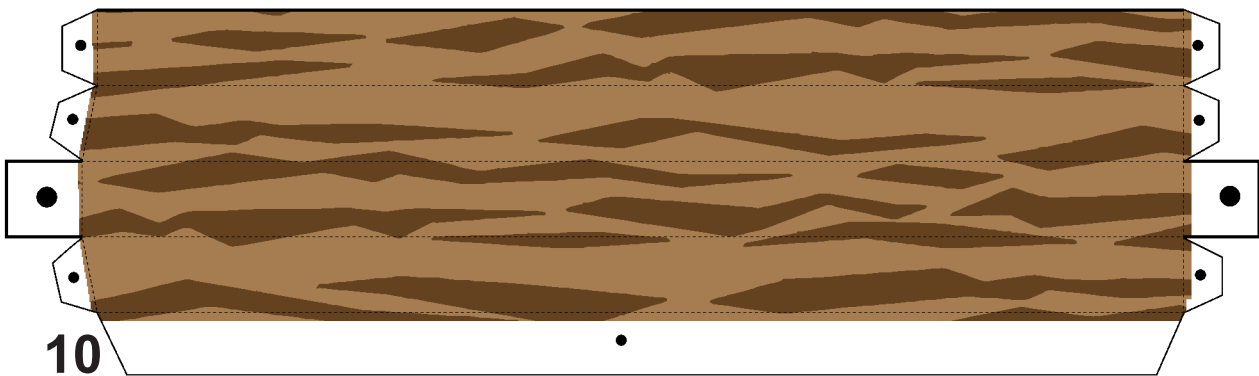

10

11

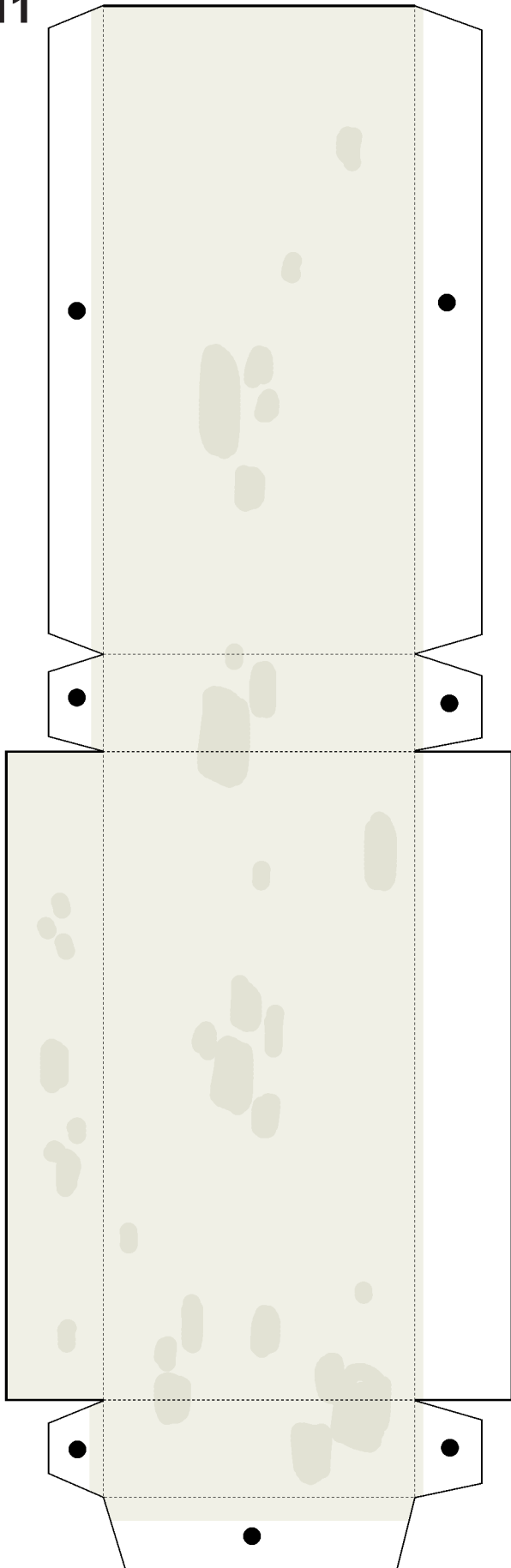

18