

**EASY TO
BUILD PAPER
CRAFT**

Bible MiniWorld

General Assembly Instructions

TOOLS NEEDED



- Sharp scissors.
- Paper-cutting knife (recommended: X-Acto knife with a #11 blade).
- Sturdy tweezers with smooth edges. (Tweezers with rough edges or teeth will mar the surface of the pieces.)
- Metal ruler to make a straight cut or score.
- Toothpicks for reaching into tiny corners and spreading drops of glue.
- White glue and glue stick.
- Cutting surface (recommended: a cutting mat).
- Dry pen (no ink) or blunt knife for scoring.

- Print pages 9 to 11 on White Card Stock paper (sometimes called Cover Paper or Bristol), 160 grammes (recommended) or 190-200 grammes (110 lbs), preferably non glossy but with a mat finish.

Cutting

Usually, a piece for a card stock model is cut out in two stages.

First, the piece is separated from the rest of the pieces by cutting roughly around it with scissors. Don't cut along the lines at this step.

Once the piece is separated, you can work on it without damaging other pieces. It's best to do the scoring and folding before proceeding to the fine cutting.

Work on one piece at a time:

- Score along the dotted lines.
- Cut along the solid lines.
- Fold along the dotted lines, but don't add glue to any pieces yet.

VERY IMPORTANT: Try out the pieces to be glued before applying the glue. This will help you understand how the pieces fit together, and you will be able to take note of any adjustments that might be needed. Then apply a small amount of glue on the tab indicated by a black dot.

Scoring

There are two kinds of folds:



Mountain fold

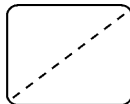

Valley fold

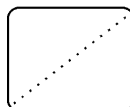

Mountain fold generally means that the texture is on the outside, while on a **valley fold** the texture is usually inside.

Score the fold lines to make a crisp straight fold. It's especially important for the smallest pieces to be scored before folding. To score, place a metal ruler along the fold line, and then press with a dull point (a dry pen or dull knife) along the fold line to compress the paper. This will help to achieve a crisp fold.

Most pieces on the model require a **mountain fold**, though a few use a **valley fold**. Valley folds will be indicated on the model pieces with the valley fold symbol.

www.mylittlehouse.org

Copyright © 2023 by Didier Martin. All rights reserved. No parts of this product may be reproduced in any form, by any electronic or mechanical means without permission in writing from the author.

Follow the steps for assembling described in the following pages. Some parts may seem to be complex, but none are complicated to assemble. Simply create one part at a time while following the order of assembly, and always try out the pieces first without glue to understand how they fit together.

Look at the final photos and the different illustrations, and with patience you will be able to create a great model.

Use a toothpick to apply a small drop of glue and a tweezer to hold the small pieces. There are a few tips added to the instructions to help you along the way.

An important key for a well-assembled model is to score neatly every piece along the dotted line, and then to prefold everything before gluing.

- Be careful when using scissors or a paper cutting knife.
- Glue, scissors, and other tools may be dangerous, so be sure to keep them out of the reach of young children.

And remember,
there is no hurry.
**TAKE YOUR
TIME!**



Assembling the Mini-people

These instructions apply to the basic shape of all mini-people. Some mini-people have additional parts.

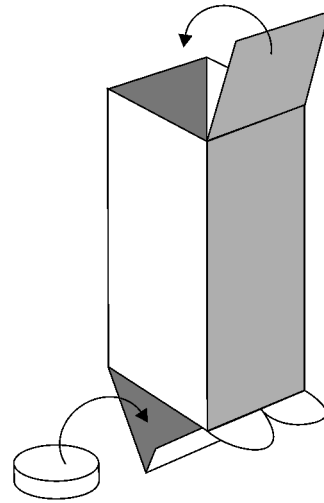
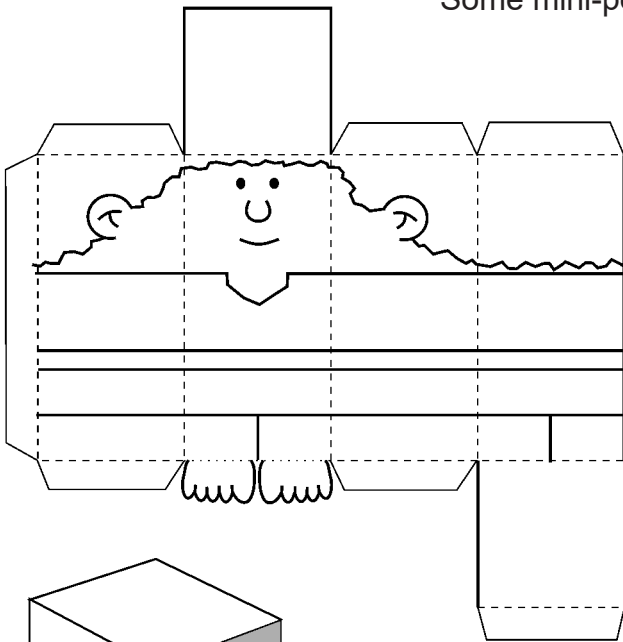

Score, cut, fold, and glue the side first; then glue the top.

Optional: Before gluing the bottom piece, glue in a small coin to add weight to the mini-people.

To form the arms: Fold in the middle, glue together, and when dry, cut around the arm.

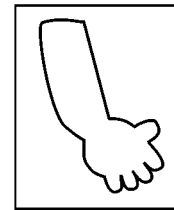
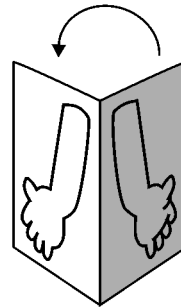
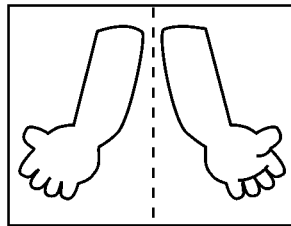
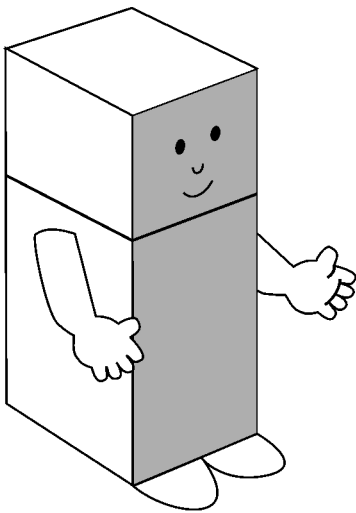

The small dot indicates where to put the glue to attach the arm to the body so that each arm is on the correct side of the body.

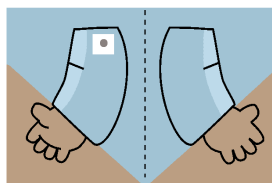
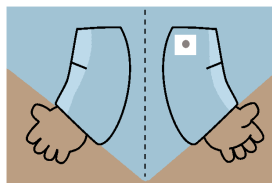

Some pieces have extra color around them, such as people's arms and accessories, for example. Fold these pieces in half and glue before cutting so that the piece will have texture on both sides.

Simply fold along the dotted line and apply some glue, preferably using a glue stick.

Once the glue on the piece has dried, cut it out. You don't have to cut right on the line; it's fine to leave a millimeter or two around it.

Assembling the background

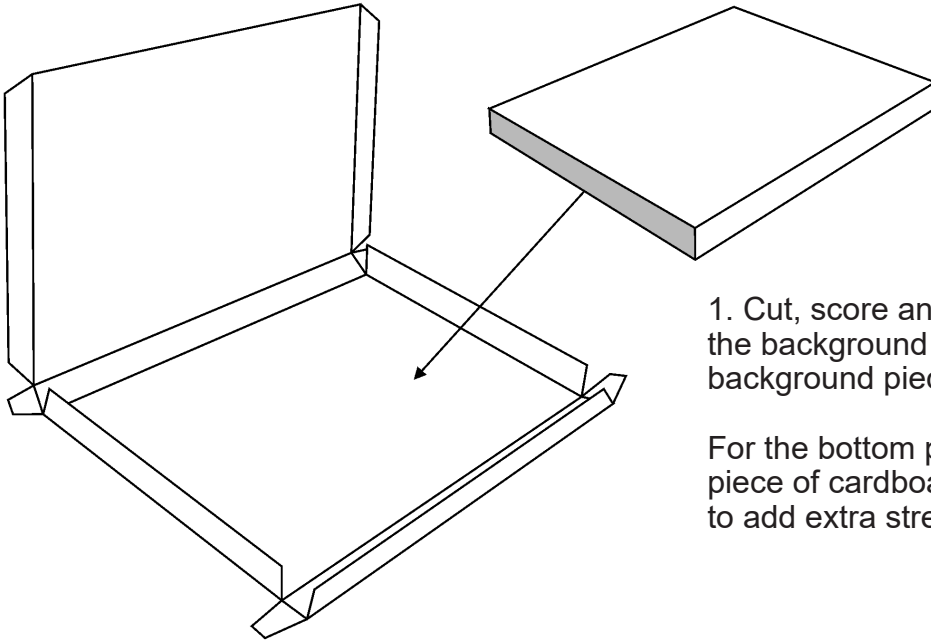

1. Cut, score and assemble the 3 parts of the background stand (the floor tile, and the background pieces A and B).

For the bottom piece, you need to insert a piece of cardboard or foam that is 5 mm thick to add extra strength.

2. Assemble the 3 parts of the background, and glue them together as shown here.

Background piece A

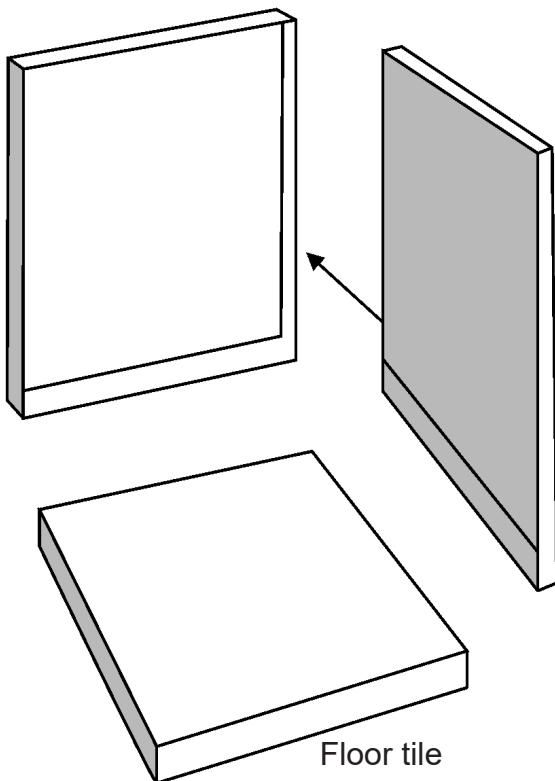

Background piece B

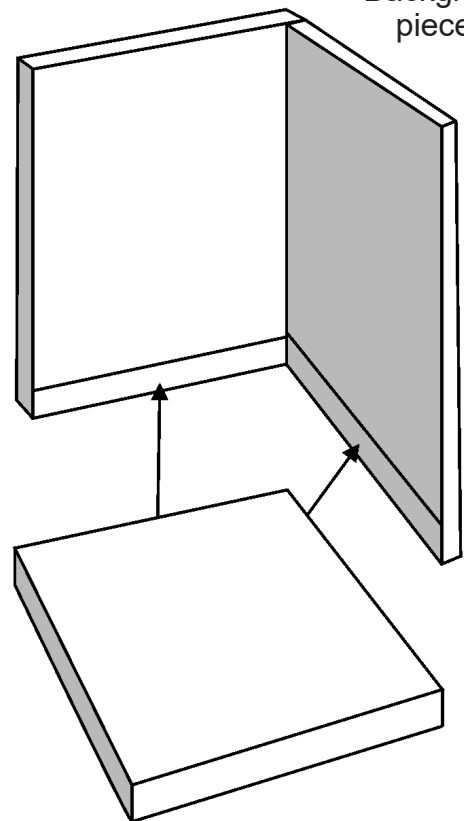

Glue the floor tile to the background pieces.

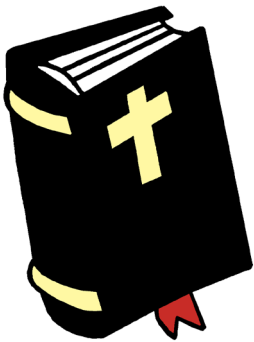

Heroes of Faith - Mary

Philip met Nathanael and told him, "We have found the man whom Moses wrote about, Jesus of Nazareth".

Nathanael said, "Can something or someone good come out of Nazareth?" Philip said, "Come and see." (John 1:46)

Yes, in this small town of Nazareth, something indeed very important happened, something that changed the whole world. An angel, Gabriel appeared to a young woman, Mary, to announce to her that she was to be the mother of the promised Messiah (Luke 1:35).

Mary was deeply disturbed by the angel's message, but she trusted God with humble belief and obedience. Mary's submission to God's plan would cause difficulties in her life, yet she was willing to be God's servant. (Luke 1:26 to 38.)

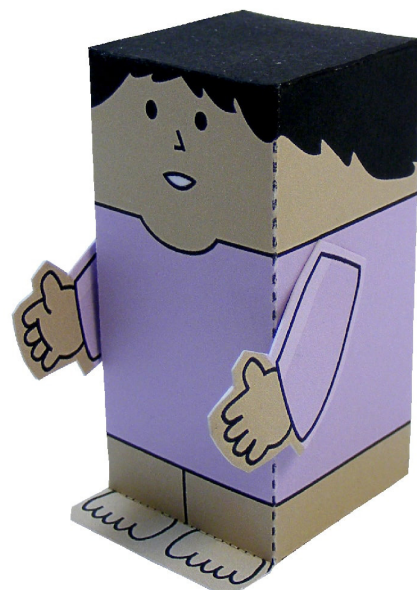
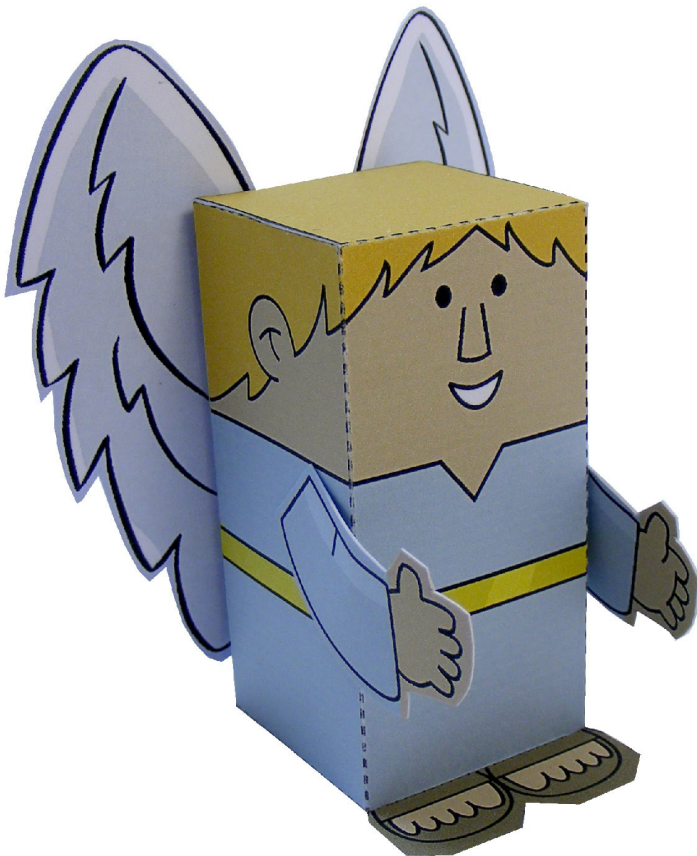
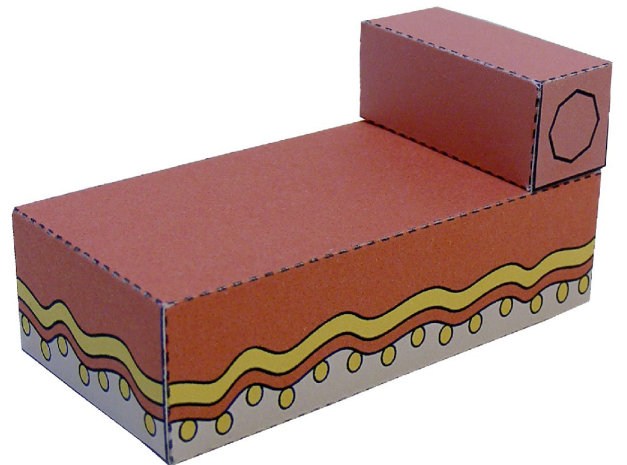
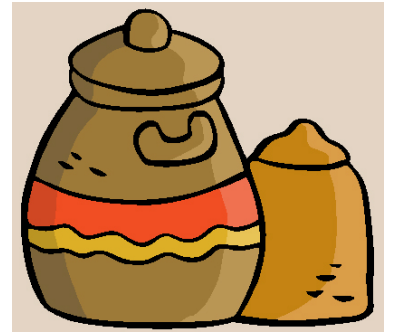
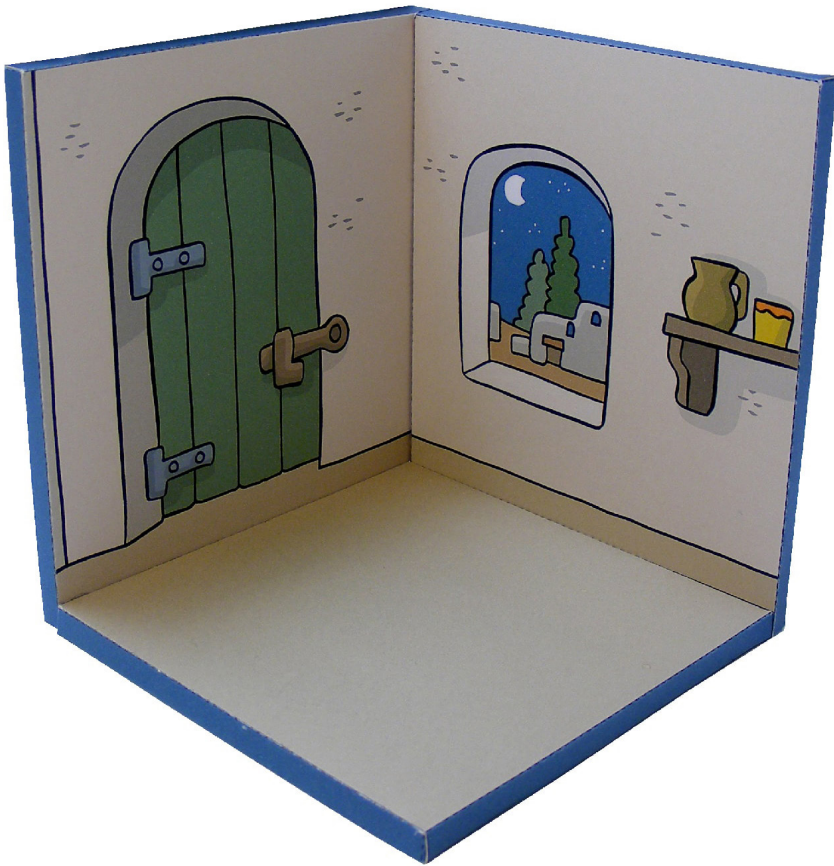

Visit my website and Etsy shop for a variety of other Bible MiniWorld sets.

<https://www.mylittlehouse.org/bible-miniworld---jesus.html>

https://www.etsy.com/shop/papercraftstoys?ref=hdr_shop_menu

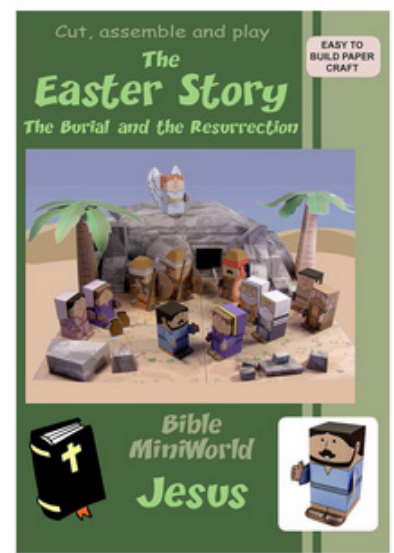
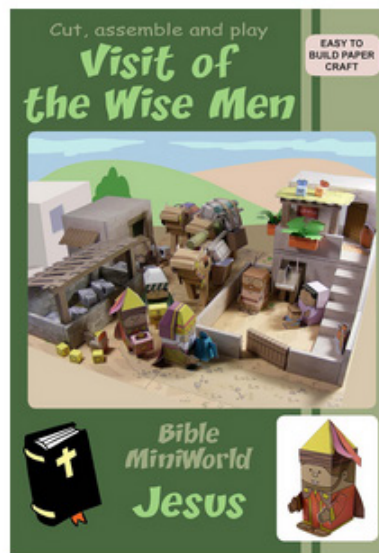
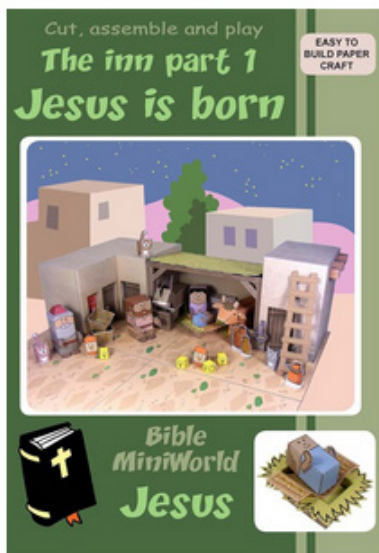
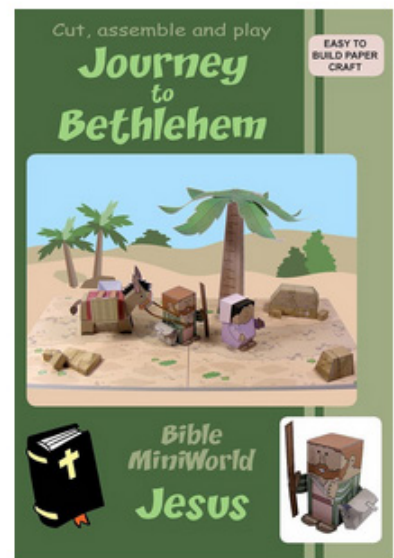
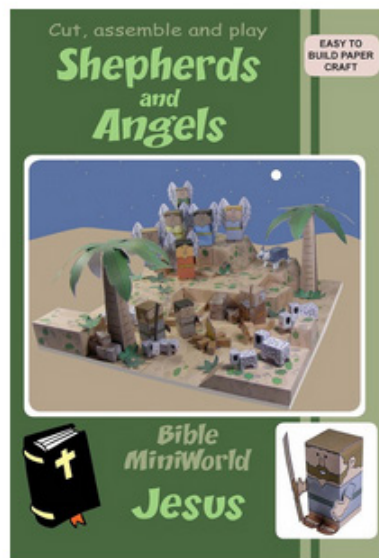
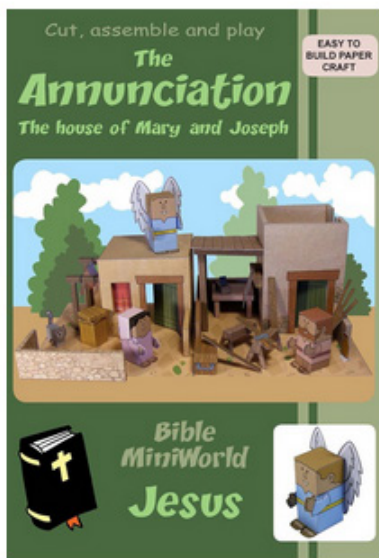

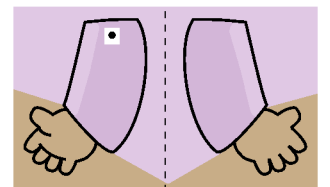
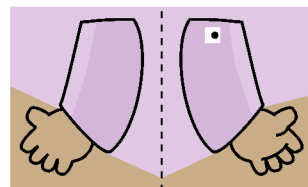
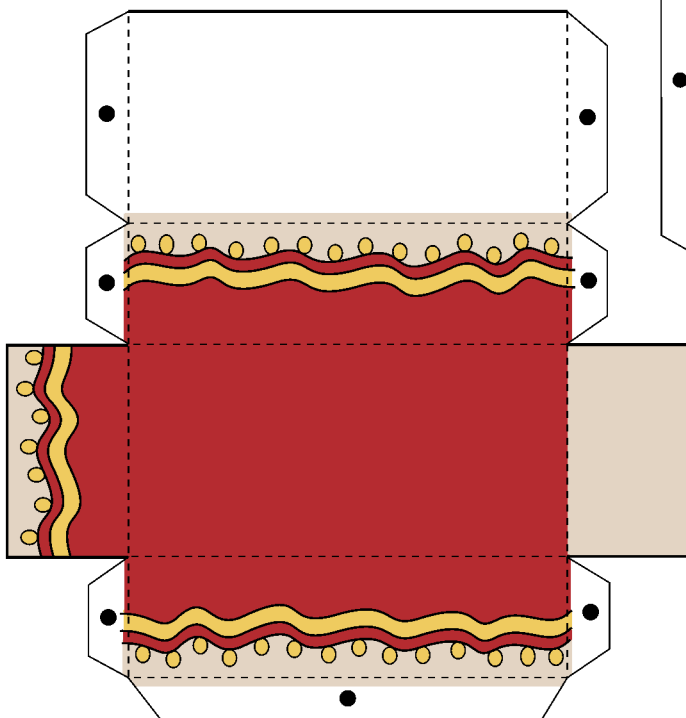
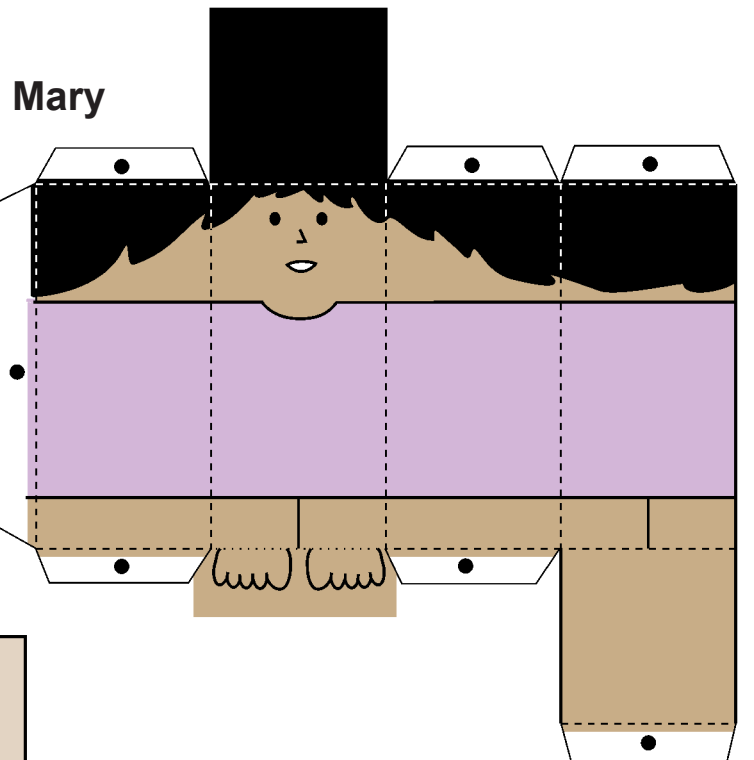
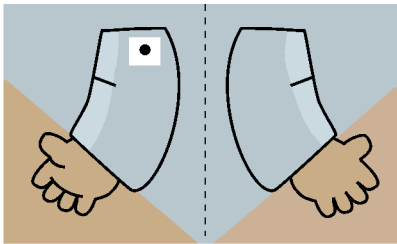
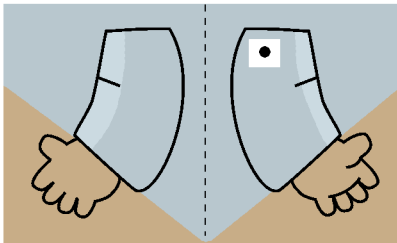
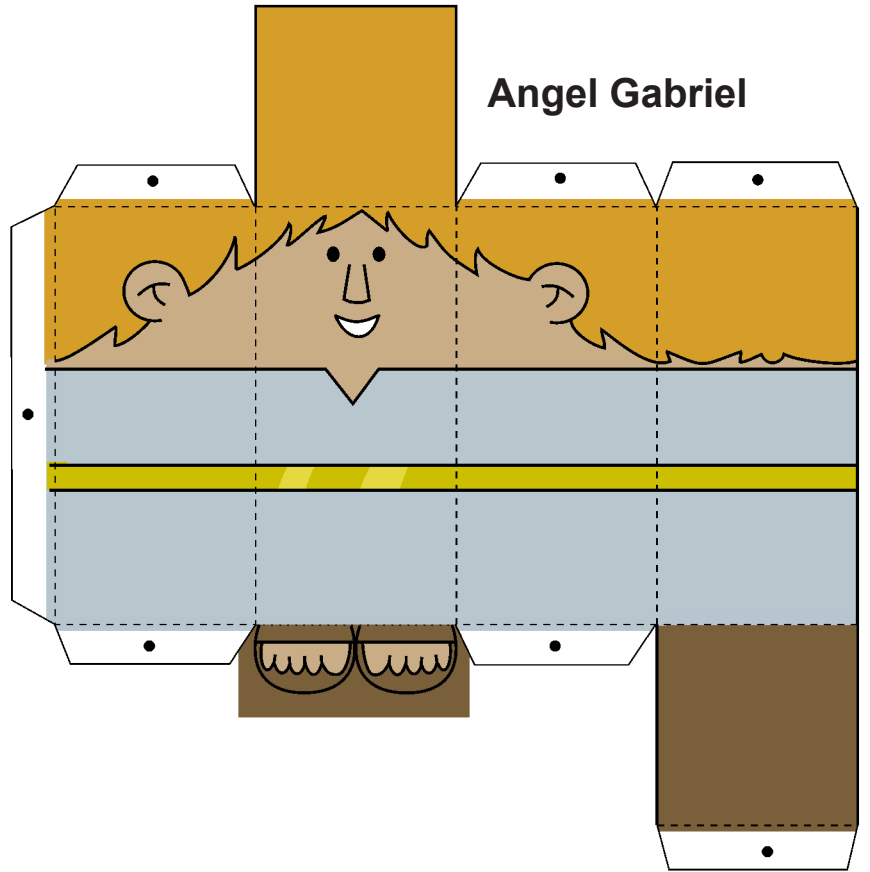
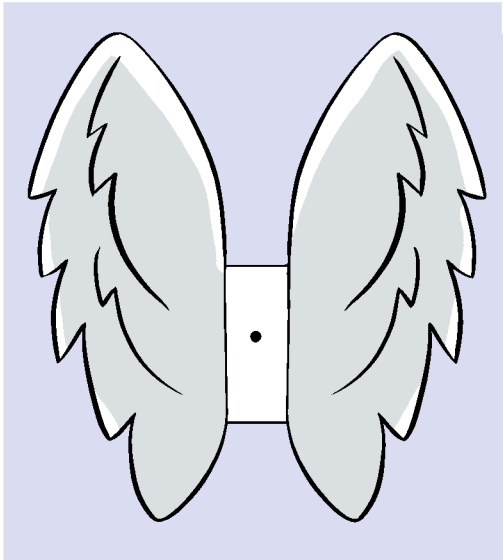

floor tile

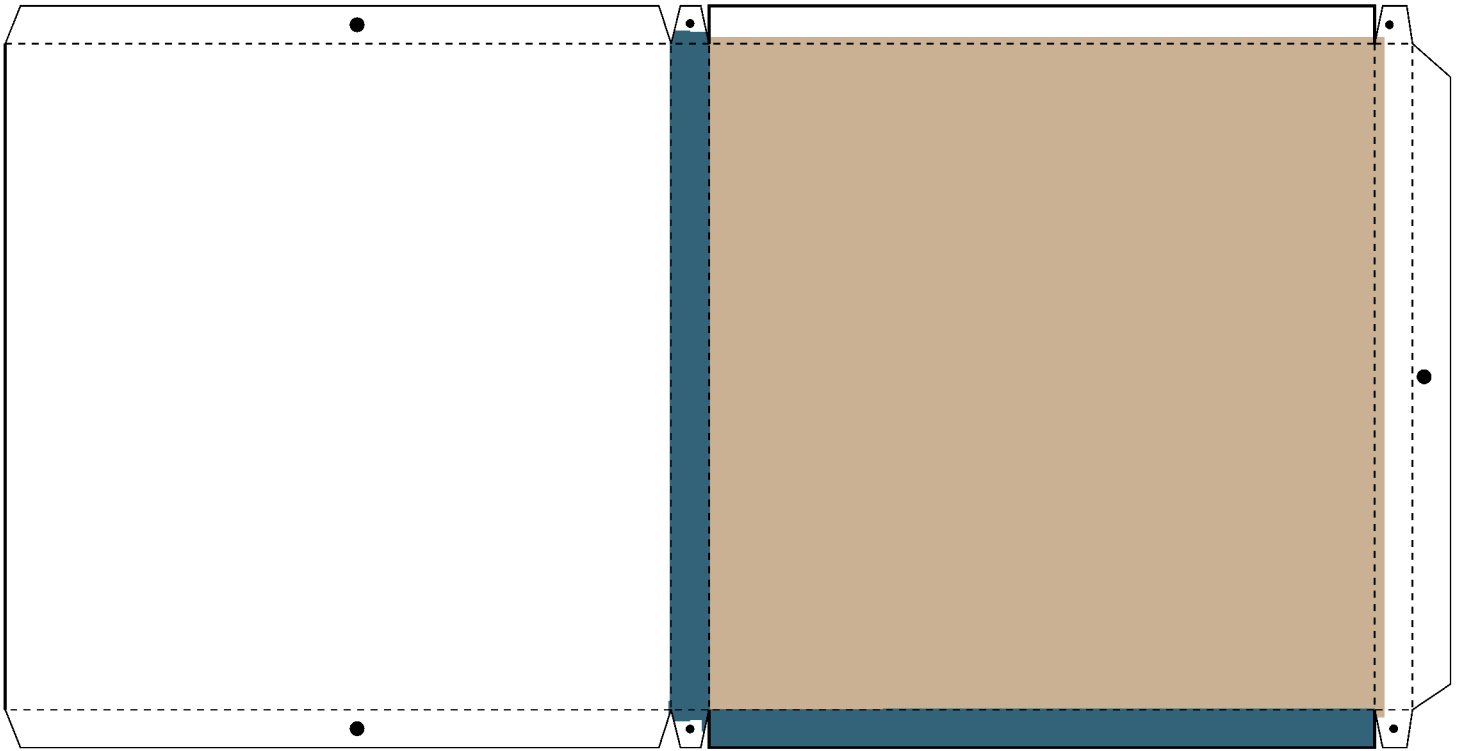

background piece B

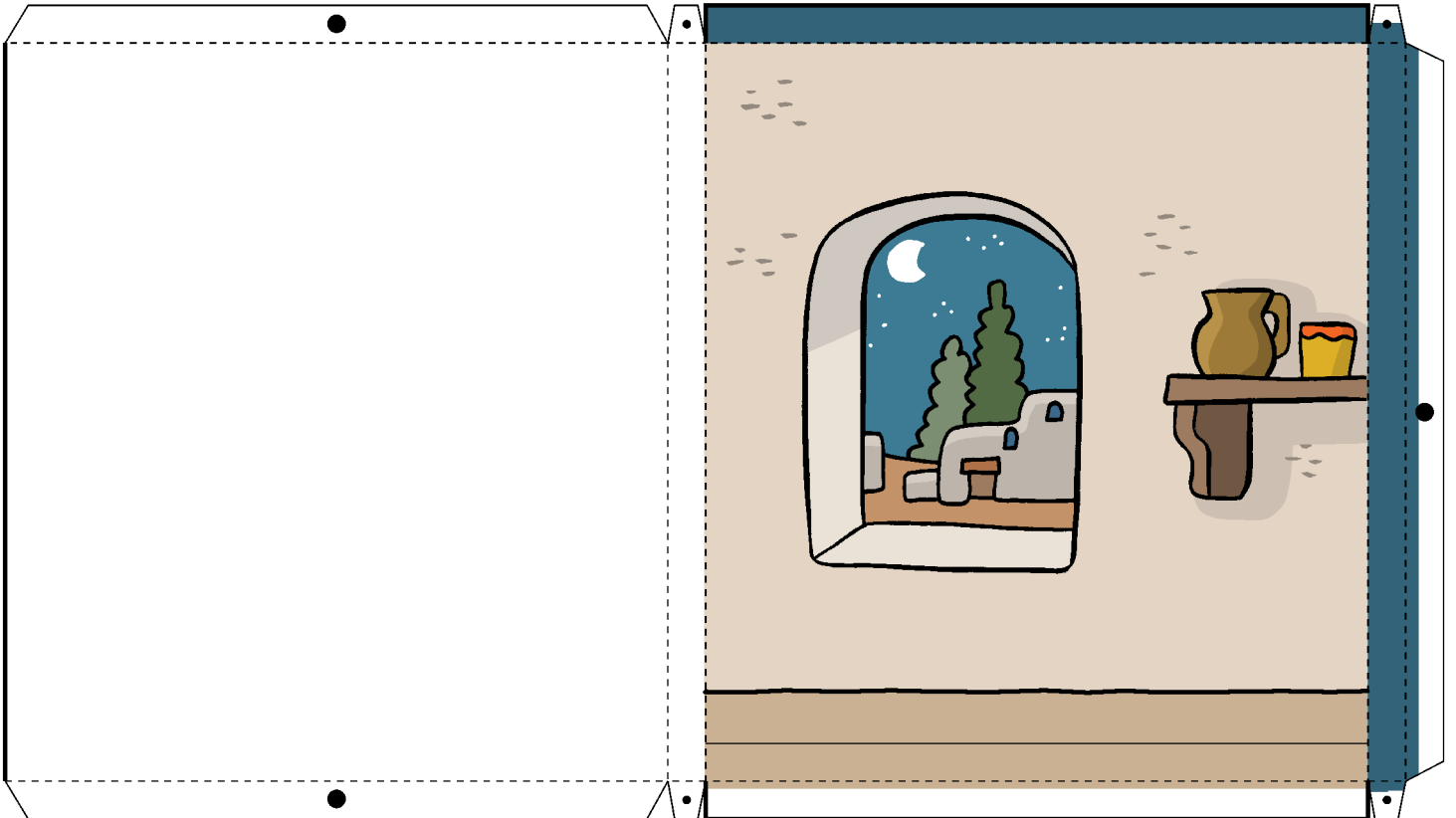

background piece A

